



# GULFPORT

INDUSTRIES INC.



## HINGE REINFORCEMENTS SECTION

PAGE 8-11

[www.gulfport-corp.com](http://www.gulfport-corp.com)

TAMPA FLORIDA USA

tel. 1-800-263-0808







fax. 1-800-663-3800

e-mail. [info@gulfport-corp.com](mailto:info@gulfport-corp.com)





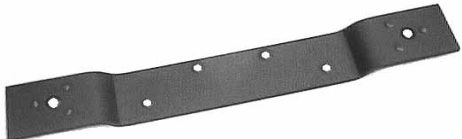
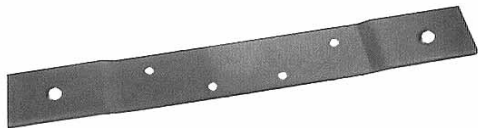

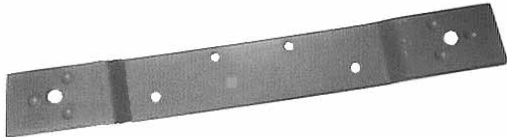

# Index

Part Names	Page
1. Frame Anchors .....	1
2. Hinge Reinforcements .....	8
3. Reinforcements .....	12
4. Glazing Bead.....	17
5. Screws .....	18
6. Lite Kits.....	20
7. Lite Kits & Accessories.....	21
8. Door & Frame Templates .....	22
9. Louvers .....	24
10. Astragals .....	25
11. Fillers .....	27
12. Shims .....	30
13. Blank-Blank Doors.....	30
14. Miscellaneous (Gaskets, Capping Channels, Edge Guards, Strike Boxes and more) .....	31
15. Strikes.....	37
16. Specialty Strikes.....	41
17. Shop Supply .....	44
18. Locks and Exit Devices.....	45
19. Hardware (Flush Bolts, Surface Bolts, Floor & Wall Stops, Mullions, Kickplates and more) .....	47
20. Pulls & Pull Plates .....	53
21. Door Holders.....	54
22. Door Closers .....	54
23. Latch Protectors.....	55
24. Door Savers .....	58
25. Thresholds, Weatherstripping, Sweeps.....	64
26. Thermal Break Joiners .....	68
27. Hinges .....	70





# HINGE REINFORCEMENTS

PART NUMBER	DESCRIPTION	ILLUSTRATION
FR 170	<b>FRAME HINGE REINFORCEMENT PLATE COVER</b> TO BE SPOT WELDED.	
FR 230	<b>FRAME HINGE REINFORCEMENT</b> FOR 4 1/2" HINGES, 1 5/8" X 8 3/4", 10 GA 4 WELDING DIMPLES ON EACH SIDE. AVAILABLE WITH OR WITHOUT WELDING DIMPLES, SPECIFY WHEN ORDERING.  <i>~ 500 PER BOX</i>	
FR 230 U	<b>UNIVERSAL HINGE REINFORCEMENT</b> FOR BOTH DOORS AND FRAMES FOR 4 1/2" HINGES, 1 1/4" X 8 3/4", 10 GA 4 WELDING DIMPLES ON EACH SIDE. AVAILABLE WITH OR WITHOUT WELDING DIMPLES, SPECIFY WHEN ORDERING.  <i>~ 500 PER BOX</i>	
FR 231	<b>HINGE REINFORCEMENT</b> FOR 6" HINGES, 1 1/4" X 12", 7 GA AVAILABLE WITH OR WITHOUT WELDING DIMPLES, SPECIFY WHEN ORDERING.	
FR 232	<b>HEAVY DUTY HINGE REINFORCEMENT</b> FOR 5" HINGES, 1 1/4" X 10", 7 GA AVAILABLE WITH OR WITHOUT WELDING DIMPLES, SPECIFY WHEN ORDERING.  <i>~ 500 PER BOX</i>	
FR 233	<b>HINGE REINFORCEMENT</b> FOR 5" HINGES, 1 1/4" X 10", 7 GA AVAILABLE WITH OR WITHOUT WELDING DIMPLES, SPECIFY WHEN ORDERING.  <i>~ 500 PER BOX</i>	
FR 234	<b>FULL WIDTH FRAME HINGE REINFORCEMENT</b> 10GA SPECIFY JAMB DEPTH AND OFFSET WHEN ORDERING.	
FR 235	<b>HEAVY DUTY HINGE REINFORCEMENT</b> FOR 4 1/2" HINGES, 1 1/4" X 10", 7 GA AVAILABLE WITH OR WITHOUT WELDING DIMPLES, SPECIFY WHEN ORDERING.  <i>~ 500 PER BOX</i>	

# HINGE REINFORCEMENTS



PART NUMBER	DESCRIPTION	ILLUSTRATION
<p><b>FR 235 A</b></p>	<p><b>HINGE REINFORCEMENT</b>            FOR 4 1/2" HINGES, 1 1/4" X 10", 7 GA            AVAILABLE WITH OR WITHOUT WELDING DIMPLES, SPECIFY WHEN ORDERING.             ALSO AVAILABLE IN 304 STAINLESS STEEL.             ~ 500 PER BOX</p>	
<p><b>FR 235 W</b></p>	<p><b>CONVERTIBLE HINGE REINFORCEMENT</b>            FOR 4 1/2" HINGES, 1 1/4" X 10", 7 GA            DIMPLES MAY BE GROUND OFF OR DRILLED OUT TO CONVERT FROM REGULAR TO HEAVY WEIGHT HINGES. CAN BE USED IN BOTH DOORS AND FRAMES. AVAILABLE WITH OR WITHOUT WELDING DIMPLES, SPECIFY WHEN ORDERING.             ~ 450 PER BOX</p>	
<p><b>FR 236</b></p>	<p><b>HINGE REINFORCEMENT</b>            FOR 3 1/2" HINGES, 7/8" X 7", 12 GA            10/24 TH'D</p>	
<p><b>FR 237</b></p>	<p><b>BLANK HINGE REINFORCEMENT</b>            FILLS 4 1/2" HINGE CUT-OUTS, 1 1/4" X 8 5/8", 10 GA            AVAILABLE WITH OR WITHOUT WELDING DIMPLES, SPECIFY WHEN ORDERING.</p>	
<p><b>FR 238 U</b></p>	<p><b>UNIVERSAL HEAVY DUTY HINGE REINFORCEMENT</b>            FOR BOTH DOORS AND FRAMES            FOR 4 1/2" HINGES, 1 1/4" X 8 5/8", 10 GA            4 WELDING DIMPLES ON EACH SIDE.</p>	
<p><b>FR 239</b></p>	<p><b>HINGE REINFORCEMENT</b>            FOR 4" HINGES, 1 1/4" X 8 5/8", 12 GA             ~ 500 PER BOX</p>	
<p><b>FR 240</b></p>	<p><b>DUST MORTAR BOX</b>            FOR 4 1/2" HINGE REINFORCEMENTS             ~ 100, 300 OR 800 PER BOX</p>	
<p><b>FR 241</b></p>	<p><b>STANLEY HINGE REINFORCEMENT</b>            FOR 4" HINGES, 1 1/4" X 8 3/4", 12 GA            AVAILABLE WITH OR WITHOUT WELDING DIMPLES, SPECIFY WHEN ORDERING.             ~ 500 PER BOX</p>	

# HINGE REINFORCEMENTS

PART NUMBER	DESCRIPTION	ILLUSTRATION
<p><b>FR 242</b></p>	<p><b>HINGE REINFORCEMENT</b> FOR 3" HINGES, 1 1/4" X 8 5/8", 12 GA</p>	
<p><b>DR 110</b></p>	<p><b>REVERSIBLE HINGE REINFORCEMENT</b> FOR BOTH DOORS AND FRAMES FOR 4 1/2" HINGES, 1 1/4" X 8 1/8", 10 GA AVAILABLE WITH OR WITHOUT WELDING DIMPLES, SPECIFY WHEN ORDERING.</p> <p><i>~ 800 PER BOX</i></p>	
<p><b>DR 222</b></p>	<p><b>HINGE REINFORCEMENT FOR ALUMINUM DOORS (ZINC PLATED)</b> FOR 4 1/2" HINGES, 1 1/4" X 8", 7 GA</p> <p><i>~ 700 PER BOX</i></p>	
<p><b>DR 370A</b></p>	<p><b>HI-FREQUENCY DOOR HINGE REINFORCEMENT</b> FOR BOTH DOORS AND FRAMES. FOR 4 1/2" HINGES, 1 1/4" X 8 3/4", 10 GA THIS AMAZING PRODUCT IS SPECIALLY DESIGNED FOR HEAVY DUTY TRAFFIC APPLICATIONS. AVAILABLE WITH OR WITHOUT WELDING DIMPLES, SPECIFY WHEN ORDERING.</p> <p><i>~ 450 PER BOX</i></p>	
<p><b>DR 370B</b></p>	<p><b>CONVERTIBLE HI-FREQUENCY HINGE REINFORCEMENT</b> FOR BOTH DOORS AND FRAMES. FOR 4 1/2" HINGES, 1 1/4" X 8 3/4", 10 GA DIMPLES MAY BE GROUND OFF OR DRILLED OUT TO CONVERT FROM REGULAR TO HEAVY WEIGHT HINGES. AVAILABLE WITH OR WITHOUT WELDING DIMPLES, SPECIFY WHEN ORDERING, 7 GA ALSO AVAILABLE.</p> <p><i>~ 450 PER BOX</i></p>	

## NOTES

# HINGE REINFORCEMENTS

PART NUMBER	DESCRIPTION	ILLUSTRATION
<p><b>BT 46</b></p>	<p><b>HINGE REINFORCEMENT</b> FOR 4 1/2" HINGES, 1 3/4" X 8 1/16", 10 GA 0.085" OFFSET</p>	
<p><b>BT 65</b></p>	<p><b>CONVERTIBLE HINGE REINFORCEMENT</b> FOR 4 1/2" HINGES, 1 1/8" X 8 3/4", 8 GA 0.120" OFFSET</p> <p>DIMPLES MAY BE GROUND OFF OR DRILLED OUT TO CONVERT FROM REGULAR TO HEAVY WEIGHT HINGES.</p>	

## ***GBB SERIES HINGES***

- **HEAVY DUTY COMMERCIAL GRADE HINGES**
- **AVAILABLE IN VARIETY OF SIZES, CONFIGURATIONS AND FINISHES**



# LOCKWOOD™

exit devices  
door closers  
cylindrical locks  
hinges  
thresholds  
kick plates  
louvers  
mortise locks  
flush bolts  
lite kits  
surface bolts



www.lockwood1878.com

1-800-446-1141 (USA/Mexico) ■ 1-888-678-9898 (Canada) ■ info@lockwood1878.com

# DISPLAY DOOR





# **GULFPORT**

**INDUSTRIES INC.**

Tel: 1•800•263•0808

Fax: 1•800•663•3800

Web site: [www.gulfport-corp.com](http://www.gulfport-corp.com)

e-mail: [info@gulfport-corp.com](mailto:info@gulfport-corp.com)

**Distributed by**

